

Disclosure belangen spreker
Symposium Verbinden & Innoveren met SNOMED CT
13 februari 2020

Geen (potentiële) belangenverstrengeling	No COI
Voor bijeenkomst mogelijk relevante relaties	FOD Volksgezondheid, Veiligheid van de Voedselketen en leefmilieu Universiteit Gent
<ul style="list-style-type: none">• Sponsoring of onderzoeksgeld• Honorarium of andere (financiële) vergoeding• Aandeelhouder• Andere relatie, namelijk: ..	<ul style="list-style-type: none">• Financiering overheid• Geen• Geen• Geen



Terminologie als motor achter de taal van de huisarts

Hoe SNOMED CT implementeren in
de dagelijkse praktijk?

David Op De Beeck
Diego Schrans
Katrien Scheerlinck

Overzicht

- ▶ Context SNOMED CT in België en 3BT
 - ▶ Roadmap
- ▶ Wat is 3BT
- ▶ Voorstelling Project
 - ▶ Mapping met SNOMED CT
 - ▶ Tooling

▶ SNOMED CT en 3BT

Belgische context

Missie Terminologiecentrum België

ACTIEPLAN eGEZONDHEID 2019-2021

Cluster 0 “Fundamenten” - Project terminologie

Doelstelling: betekenisvol uitwisselen van gegevens tussen zorgactoren (semantische interoperabiliteit)

Op basis van éénduidige codering

Concreet: faciliteren volledige implementatie van SNOMED CT

Hoe?

- SNOMED CT beschikbaar stellen in taal eindgebruiker
 - Belang van vertalingen - lokalisatie
 - Waar mogelijk vertrekkend vanuit taal van “werkveld”

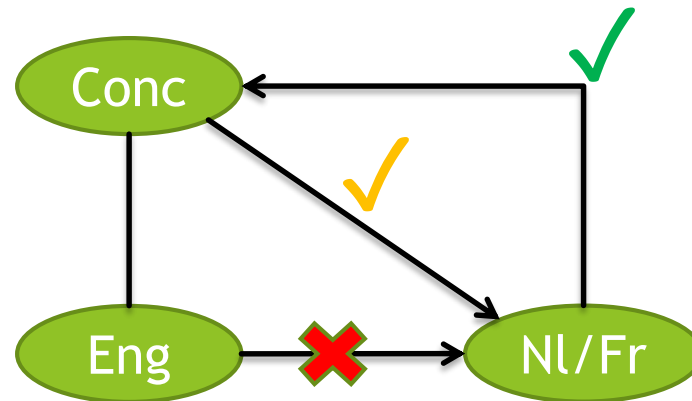

Roadmap 2020-2021

2020		2021	
RELEASE 5	RELEASE 6	RELEASE 7	RELEASE 8
Eerste refsets			
	- Resp. System - Thesaurus 3BT		
		- Cardiov. System - Thesaurus 3BT	
			- Musculosk. System - Thesaurus 3BT

- **VANDAAG:** +/- 40.000 concepten met gevalideerde vertaling NL/FR
- **BINNEN 2 JAAR:** +/- 100 000 concepten met gevalideerde vertaling NL/FR
- **Relevantie belangrijker dan volume!** (use case-ondersteunend)

3BT-SNOMED CT: verschillende stakeholders ...

Insteek huisartsen

Dossiervoering in eigen vakjargon
Behoud en versterking 3BT

Continuïteit en behoud
historische informatie in EMD's
Behoud link met SW-pakketten

Insteek Terminologiecentrum

Eén gemeenschappelijke
taal in de zorg

Semantische interoperabiliteit
tussen alle zorgactoren

Andere projecten Actieplan eGezondheid

Codering diagnoses
Uitwisseling Sumehr's

... met gemeenschappelijke belangen



Waarom mapping 3BT - SNOMED CT?

- 3BT = optimale vertaling voor SNOMED-concepten
- Koppelen 3BT aan gemeenschappelijke terminologie

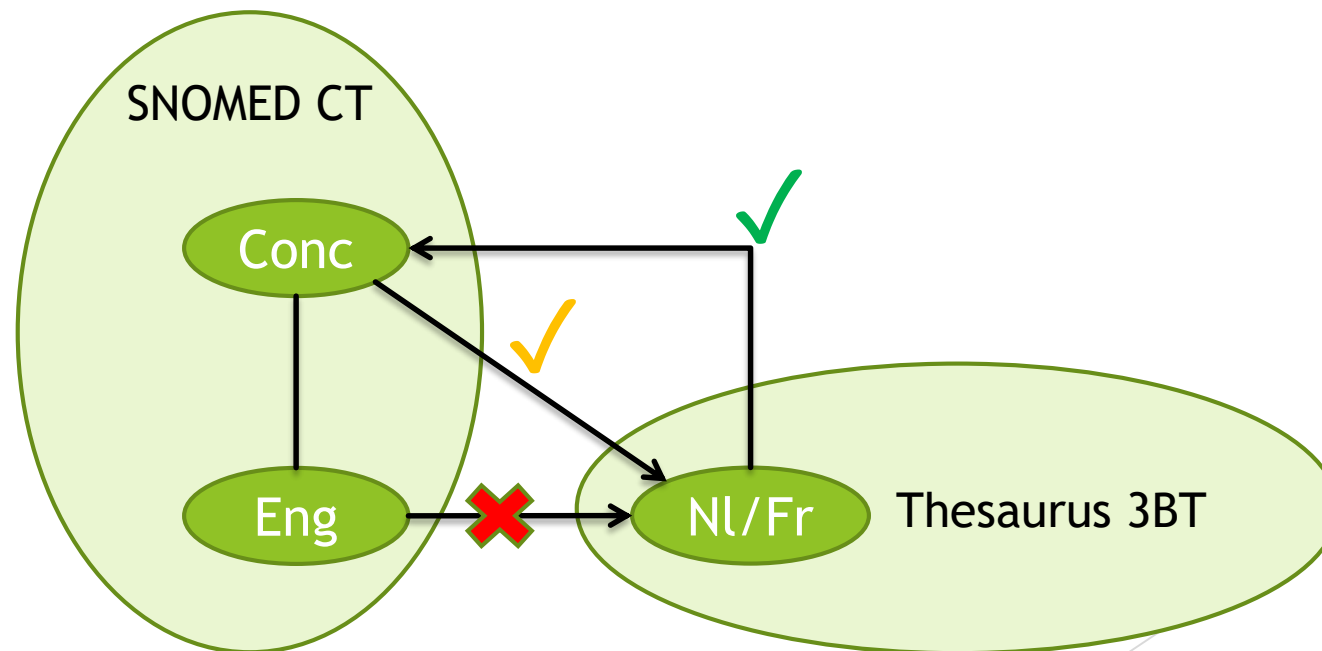

Van het verleden: twee sporen ...

- ▶ Focus 3BT ⇔ focus overheid
- ▶ Interfaceterminologie 1^{ste} lijn vs. Referentieterminologie 1^{ste}/2^{de}/3^{de} lijn
- ▶ Oriëntering middelen naar SNOMED CT

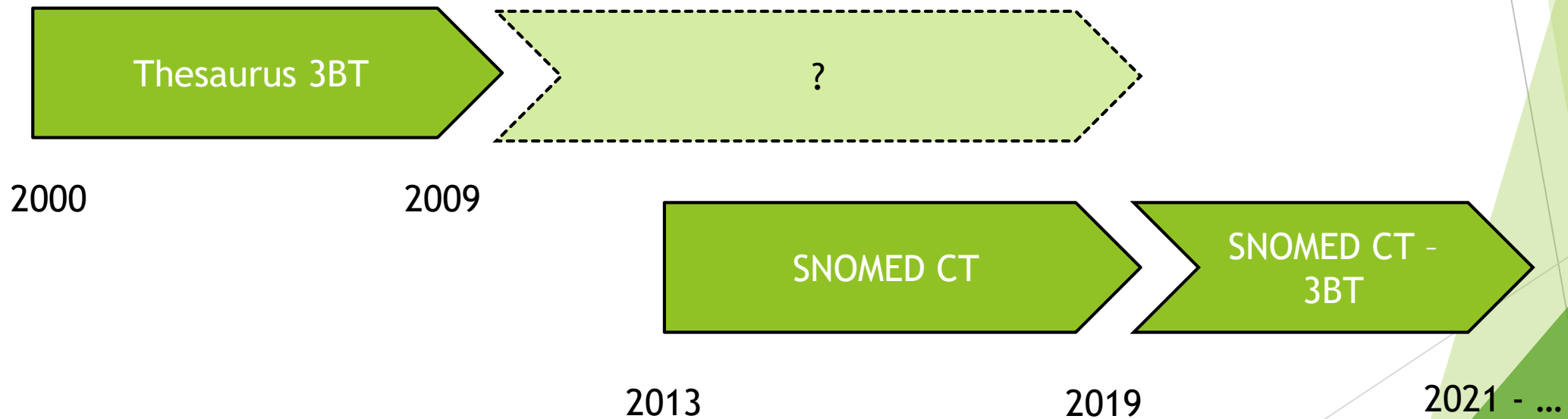

... naar vandaag: een gemeenschappelijk traject

- ▶ Bundelen van krachten, middelen, expertise

Huisartsen

Link met werkveld 1^{ste} lijn
Link met software vendors
Beschikbaarheid resources
(tooling en codeurs)

Expertise SNOMED CT (NRC)
Kwaliteitsgarantie mapping
Financiering

Overheid

Meerwaarde mapping 3BT - SNOMED CT

- Op vlak van thesaurus 3BT
 - Upgrade => betere kwaliteit, afstemming op gebruiker
 - Continuïteit van historische medische gegevens
- Op vlak van SNOMED CT
 - Verankering van SNOMED CT in terminologie van “eindgebruiker”
 - Implementatie van Snomed CT in de EMD's
 - Efficiëntere communicatie tussen verschillende disciplines
 - Gegevensdeling tussen verschillende medische dossiers/zorgactoren



▶ Wat is 3BT

Daily practice or Where The magic happens: Communication or the art of being understood

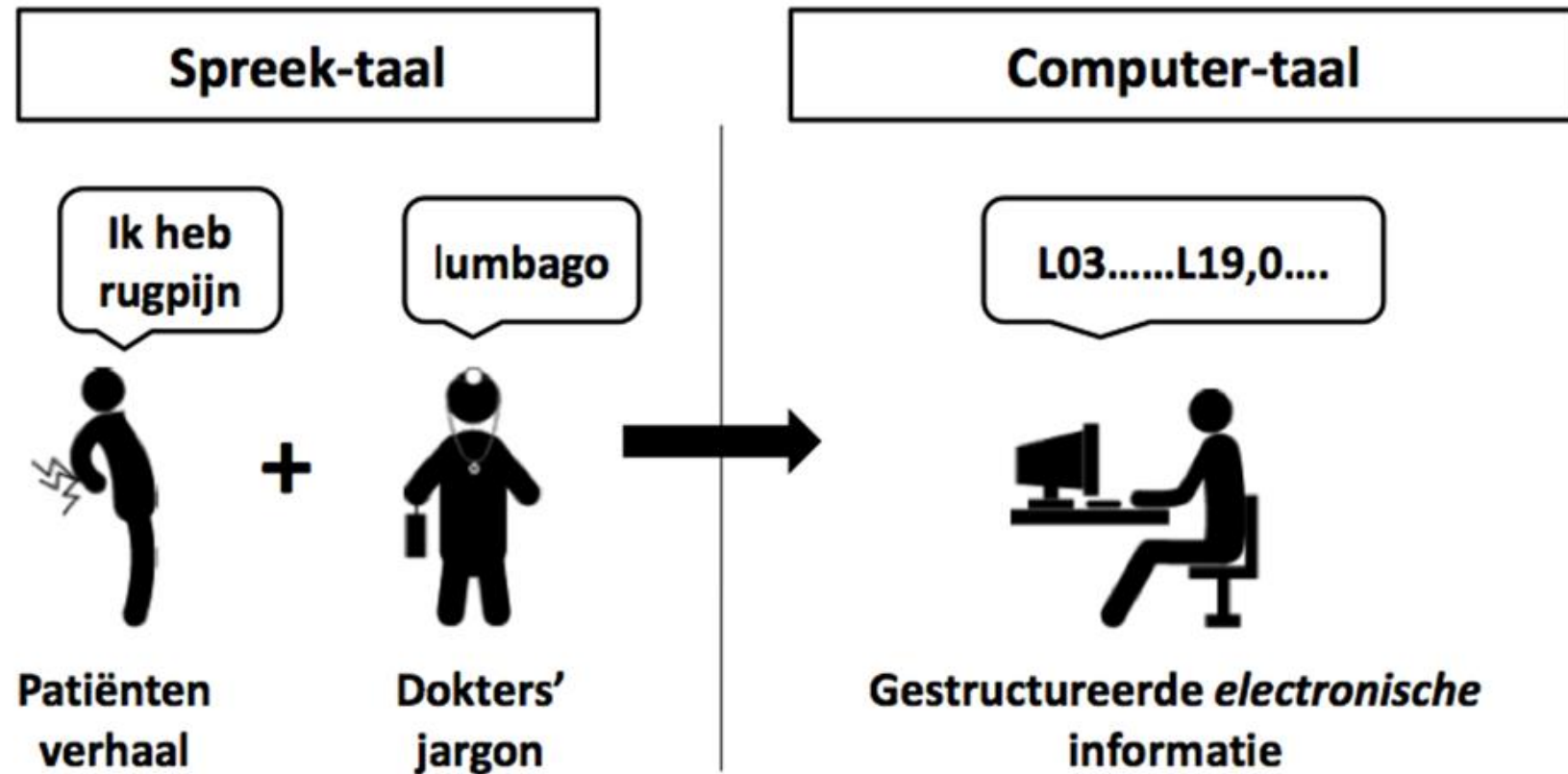

The dream...

éénmalig, eenvoudig, en correct registreren voor meervoudig gebruik



► “If language is not used correctly, what is said is not what is meant.”

To make the language in clinical information systems unambiguous: code systems, classifications and terminology standards are used to produce a translation of the clinical information to an interoperable and machine readable correct (medical) concept.

The International Classification of Primary Care (ICPC-2): an essential tool in the EPR of the GP

Marc Verbeke M.D.¹, Diëgo Schrans M.D., Sven Deroose M.D.,
Jan De Maeseneer M.D. Ph.D
*Department of General Practice and Primary Health Care,
Ghent University, Belgium*

Abstract. The International Classification of Primary Care (ICPC) has become a standard all over the world. It became a standard tool to classify the important elements in the Electronic Patient Record (EPR) of the GP: reasons for encounter (RFE) reflecting the patient's view, process of care (decision, action, intervention or plans) reflecting the care process, and the assessment (diagnosis or health issue) reflecting the doctor's view. ICPC-2 is fully compatible with structuring data in the episode of care model and it's reflecting the essential elements of each patient/provider encounter. To implement ICPC-2 in the EPR a Thesaurus has been developed in Belgium with double encoded clinical labels. The implementation is now mandatory for labeled EPR systems in Belgium. The use of ICPC 2 ay improve the accessibility and use of on-line Expert systems and Guidelines.

Keywords: Medical Informatics, ICPC, primary care, thesaurus, medical record.

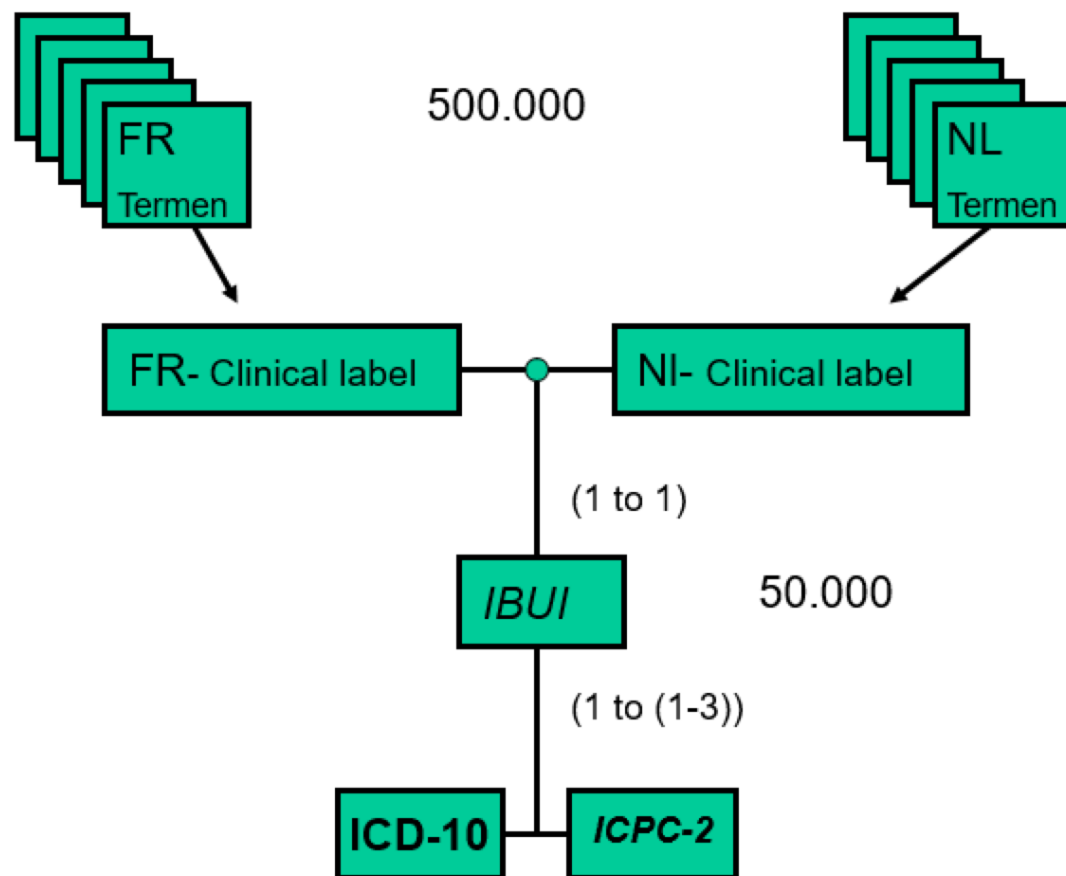

3BT:

Belgian Bilingual Thesaurus

Contact

Journal

Nieuw

Overzicht

Log

Reden

koor

+

koorts (A03, R50.9)

Subjectief

klierkoorts (A75, B27.9)

+

aanhoudende koorts (A03, R50.8)

Objectief

urosepsis (U71, N39.0)

+

herpes simplex labialis (S71, B00.1)



Evaluatie

koortsblaas (S71, B00.1)

+

Meer zoekresultaten...

Zorgelement



niet linken



maak nieuw

link aan bestaand



Handeling

+



Code

ICPC

Thesaurus

ICPC hoofdstuk

- A Algemeen en niet gespecificeerd
- B Bloed, bloedvormende organen e...
- D Spijsverteringsorganen
- F Oog
- H Oor
- K Cardiovasculair stelsel
- L Bewegingsapparaat
- N Zenuwstelsel
- P Psychische problemen
- R Luchtwegen
- S Huid
- T Endocriene klieren/ stofwisseling/

ICPC code

- A01  gegeneraliseerde pijn/pijn n
- A02  koude rillingen
- A03  koorts**
- A04 Inclusie:febris, pyrexie
- A05 Exclusie:koorts met exantheem A76; zonnesteek A88
- A06
- A07  coma
- A08  zwelling

Thesaurus-term

- aanhoudende koorts
- aanhoudende pyrexie
- febricula
- febris e.c.i.
- hoge temperatuur
- hyperpyrexie
- hyperpyrexie van onbekende oorsprong
- hyperthermie
- ininitiekoorts
- intermitterende koorts van onbekende oo.
- koorts
- koorts bij lege artis jodiumgebruik

Code

ICPC

Thesaurus

 Zoek

Thesaurus term	ICPC	ICD	
reumaase koorts	A70	A77.1	
klierkoorts	A75	B27.9	
koorts	A03	R50.9	
koorts bij lege artis jodiumgebruik	A03	R50.9	
koorts bij lege artis steroïdengebruik	A03	R50.9	
koorts bij pasgeborene	A94	P81.9	
koorts bij pasgeborene door omgeving	A94	P81.0	
koorts door hitte	A88	T67.0	
koorts door jodium bij overdosis of toedienen van verkeerde stof	A84	T48.4	
koorts door teken overgebracht	A77	A93.8	
koorts met koude rillinaen	A03	R50.0	

10049305 : koorts

 Annuleer

 OK



Bron

Formularium Ouderenzorg
Farmaka (2)

Patiënt info (2)

ebpracticenet (2)

NHG (1)

pallialine (1)

Verder zoeken



Verder zoeken



Vanaf heden is in het kader van de [telematica premie](#) voor huisartsen noodzakelijk om in te loggen.

In samenwerking met eHealth zal het automatisch inloggen vanuit het EMD zo snel als mogelijk gerealiseerd worden.

Koorts bij een kind Duodecim Medical Publications Ltd	ebpracticenet
Langdurige koorts bij volwassenen Duodecim Medical Publications Ltd	ebpracticenet
koorts	Formularium Ouderenzorg Farmaka
koorts	Formularium Ouderenzorg Farmaka
Aanhoudende koorts bij volwassenen	Patiënt info
Koorts	pallialine
Kinderen met koorts	NHG

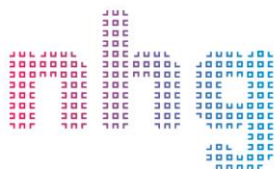

Nederlands
Huisartsen
Genootschap

Direct naar ▾

NHG-Leeromgeving

Inloggen

Winkelwagen

Zoeken



Home
WELKOM

Actueel
& TIJDSCHRIFTEN

Richtlijnen
& PRAKTIJK

Onderwerpen
& ZOEKEN

Scholing
& E-LEARNING

Organisatie
& BELEID

Winkel
& BESTEL

NHG-
Standaarden

[Home](#)

Kinderen met koorts

Samenvattingskaart M29

Cluster: A. Algemeen

Status: Actueel - 2016

Inhoudsopgave

[Richtlijnen diagnostiek](#)

- [Anamnese](#)

Standaard M29

[Bekijk volledige versie](#)

[Download volledige versie](#) (1.58 MB)

Feedback

Tegen welke problemen of onduidelijkheden loopt u aan bij het gebruik van deze richtlijnen? We horen het graag!

[Reacties bekijken](#)

HAweb
Netwerk voor huisartsen

Voorstelling mapping project



PROJECT



MAPPING
PROCESS



TOOLING

Projectomschrijving

- ▶ Eerste fase: Proof Of Concept (PoC)
 - ▶ Selectie en extractie van de 1000 meest frequente termen van de thesaurus 3BT uit EMD (Pricare)
 - ▶ Mapping tussen term van de 3BT selectie en een SNOMED CT-concept
 - ▶ Verificatie van bestaande mappings (ICPC-2 en ICD-10)
 - ▶ Aan de hand van POC methodologie en tools op punt stellen



Opname in de Belgische SNOMED CT extensie September 2020

Projectomschrijving

- ▶ Tweede fase: Vervolgproject

- ▶ Uitbreiding naar 10 000 meest relevante termen in de huisartsenpraktijk

- ➡ Opname in de Belgische SNOMED CT extensie September 2020

- ▶ Derde fase: uitbreiding naar mapping volledige 3BT thesaurus

- ➡ Te bepalen

Selectie 1000 termen voor mapping in POC

← Afbakenen POC

Contextgebonden betekenis bepalen 3BT term

← Woordbetekenis en definitie bepalen
Overeenstemming NL/FR 3BT term

Mapping

← Selecteer SNOMED-CT Code
Check bestaande ICPC2/ICD10 map

Aanpassing bestaande 3BT met mapping naar SNOMED CT

← Finale methodologie
Tooling op punt

Vervolgproject: 10 000 termen

One code system

Another code system

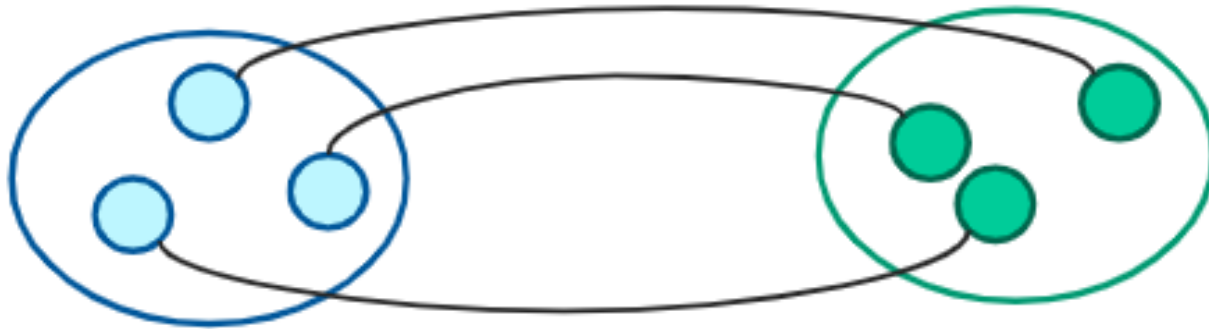

Mapping Process

Mapping Proces: algemeen

- Proces documenteren in mapping guide
 - Mapping is contextgebonden
 - Geen lexicale mapping
 - De betekenis achter de IBUI term binnen de 1^e lijn-huisartsenpraktijk kennen
 - Manuele map (versus automap)
 - Ondersteuning door tool Transmed
 - Bidirectionele mapping, met daarom streven naar
 - One-to-one map
 - Exact matches

Mapping Proces: afspraken maken

Mapping level

Precisielevel	Relatie 3BT en SNOMED CT	Voorbeeld
Exact Match (EM)	3BT is identiek aan SNOMED CT	Rinitis = Rinitis
Narrow to Broad (NtB)	3BT is meer specifiek dan SNOMED CT	Chronische Rinitis +/- Rinitis
Broad to Narrow (BtN)	3BT is minder specifiek dan SNOMED CT	Rinitis ≠ Chronische Rinitis
No Match	No Match tussen 3BT en SNOMED CT	Rinitis = ?

3BT term
beoordelen

SNOMED CT
concept
beoordelen

Mapping Proces: afspraken maken

Ideale mapping patroon

- One-to-one mapping

Overige mapping patronen

- One-to-many mapping
- Many-to-one mapping
- One-to-none mapping

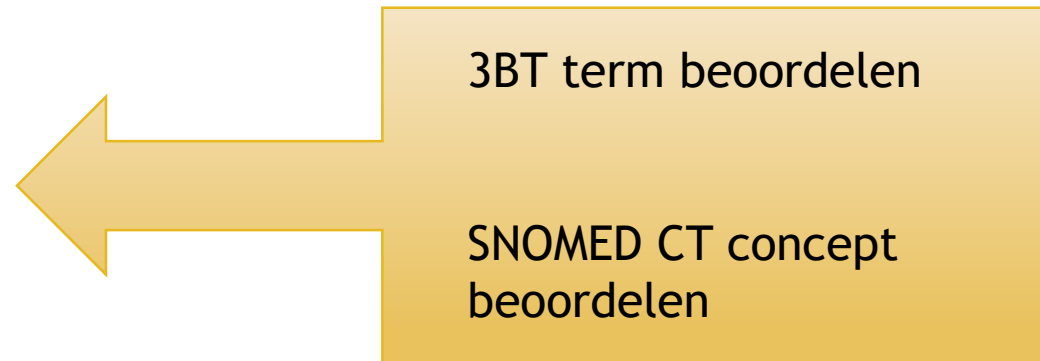

Dual mapping process

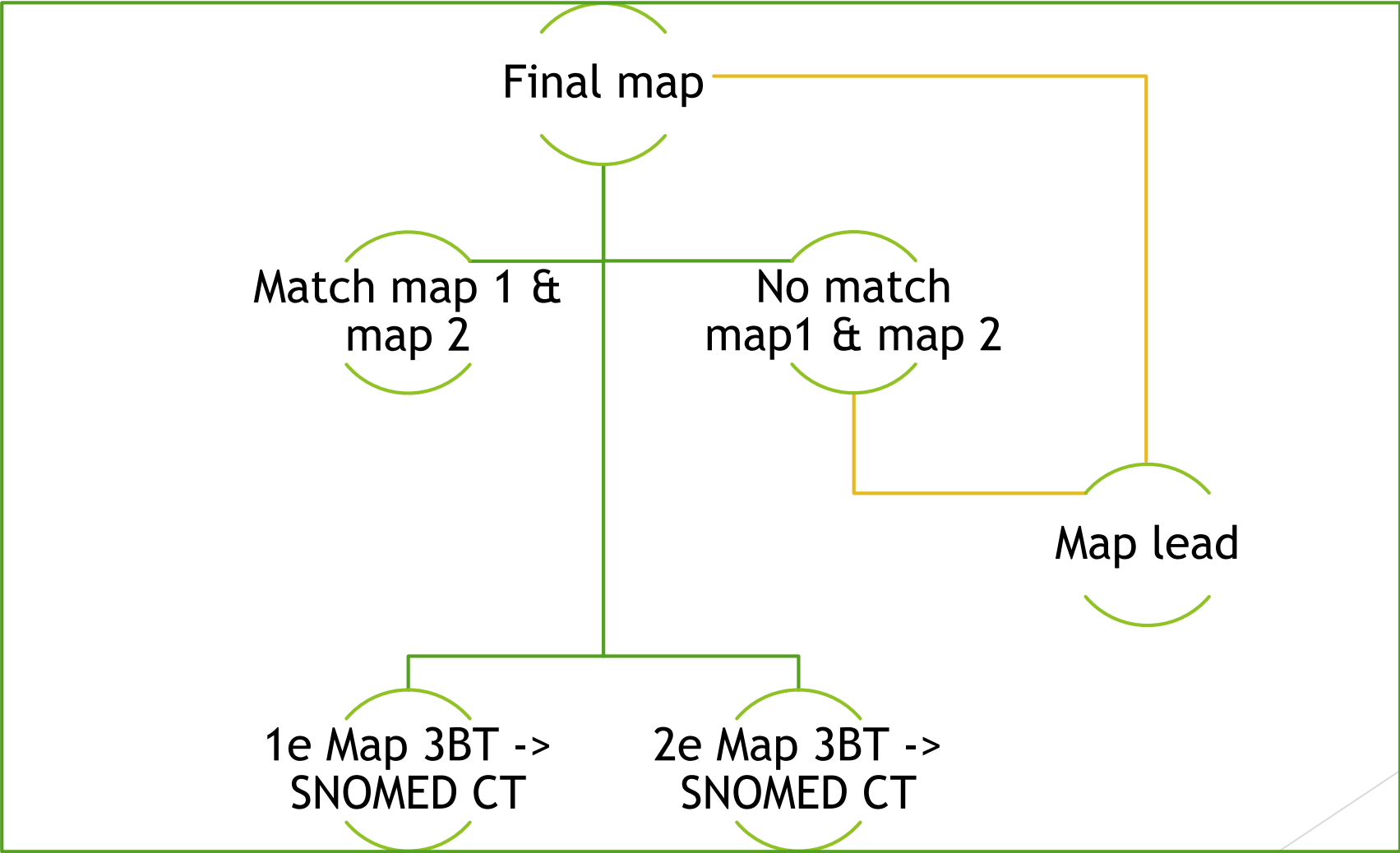

Uitdagingen

- ▶ Specifieke profielen nodig
 - ▶ Medische profielen
 - ▶ Kennis hebben over de huisartsenpraktijk
 - ▶ 3BT kennen
 - ▶ Voldoende kennis SNOMED CT
 - ▶ Educatie
 - ▶ Voldoende kennis ICPC 2 en ICD 10
 - ▶ Zijn elkaars 'peer'

Uitdagingen

- ▶ 'Project' eindigt niet
- ▶ Onderhoud
 - ▶ Medische wereld evolueert
 - ▶ (6 maandelijke) updates SNOMED CT
 - ▶ Updates 3BT
 - ▶ Evoluties naar ICPC3 en ICD11
 - ▶ ...
- ▶ Belangrijk dat de map reproduceerbaar is
 - ▶ Methodologie moet helder en volledig zijn (*mapping guide*)

The background features a complex geometric design. On the left, there are overlapping, semi-transparent shapes in various shades of green and a dark blue-grey. These shapes create a sense of depth and movement. The right side of the image is a solid, bright lime green. Centered on this green background is the text '▶ Tooling' in a clean, white, sans-serif font.

▶ Tooling

Transmed features

- ▶ Web-designed - online working
- ▶ Multi-user
- ▶ Multi-lingual
- ▶ Multi-terminology

Transmed workflow

1. Importation: local words list, local vocabulary, local thesaurus (source)
2. Mapping local vocabulary to one (or many) terminology (target): by two coders
3. Reviewing mapping: benchmarking of coders
4. Export resulting mapping

1 - import source vocabulary

- ▶ Belgian bilingual thesaurus: 3BT
- ▶ Pinning the original term/concept



Transmed

Encodage

✖ gastritis

Mapping des termes Mapping des codes Recherche

Codé Validé Pas pertinent PostCo Ib... Neederlands Catégorie Type

Page 2 sur 5

id		->	<-	v	v	v	v	->
10035182	gastritis							
10035231	virale gastro-enteritis							
10036310	geïnfecteerde urine							
10038382	glucose intolerantie							
10039597	handpijn							
10041728	hoesten							
10041859	hoofdpijn							
10042065	huidmycose							

2 - map to targets terminologies

Transmed

Encodage

gastritis Pas per

Mapping des termes | Mapping des codes | Recherche de code

Recherche de code

Snomed CT contient gastritis actif

Page 1 sur 1 Codes 1 - 8 sur 8

Code	Version	Nom	+	?	g	->
723096000		Gastritis caused by bacterium (disorder)				
723097009		Gastritis caused by fungus (disorder)				
708165001		Gastritis caused by Helicobacter heilmannii (disorder)				
708164002		Gastritis caused by Helicobacter pylori (disorder)				
708964003		Gastritis cystica profunda (disorder)				
4556007		Gastritis (disorder)				
52305004		Gastritis medicamentosa (disorder)				
276527006		Gastritis of newborn (disorder)				

Les synonymes / Terme

Anglais

Liens | Parents : 0 Enfants : 0

+ ? g -> Relation

Liens avec les termes

Libellé

SCT synonyms and relationships

SNOMED CT Browser

Release: Belgian Edition 2019-09-15

Perspective: Full

Feedback

About

Parents

Mycobacteriosis (disorder)

Tuberculosis (disorder)

SCTID: 56717001

56717001 | Tuberculosis (disorder) |

en Tuberculosis

en TB - Tuberculosis

en Tuberculosis (disorder)

fr tuberculose

nl tuberculose

Pathological process → Infectious process
Causative agent → Mycobacterium tuberculosis complex

Children (65)

- Active tuberculosis (disorder)
- Acute tuberculous pericarditis (disorder)
- Acute tuberculous ulcer (disorder)
- Caseating tuberculoid granuloma (disorder)
- > Chronic tuberculosis (disorder)
- Congenital tuberculosis (disorder)
- > Disseminated tuberculosis (disorder)
- > Drug resistant tuberculosis (disorder)

Browsing Snomed-CT

- ▶ Lexical search: the search motor
 - ▶ Dutch/french/english
 - ▶ On all descriptions and synonyms
- ▶ Semantic search
 - ▶ children and parents
 - ▶ Other relations
 - ▶ « is_a » tree: visualize all paths leading to a concept



Browsing Snomed-CT

Transmed

Encodage

Term
Code

Pas pertinent Niveau de pre

Mapping des termes Mapping

Recherche de code

Snomed CT contient chronic gastritis actif

Page 1 sur 1 Codes 1 - 12 sur 12

Code	Version	Nom	+	?
8493009		Chronic gastritis (disorder)	+	?
698352000		Chronic antral gastritis with hemorrhage (disorder)	+	?
89790007		Chronic antral gastritis (disorder)	+	?
235661004		Chronic cystic gastritis (disorder)	+	?
63137003		Chronic erosive gastritis (disorder)	+	?
235660003		Chronic follicular gastritis (disorder)	+	?
235662006		Chronic granulomatous gastritis (disorder)	+	?
196735001		Chronic superficial gastritis (disorder)	+	?
84568007		Atrophic gastritis (disorder)	+	?
60002000		Hypertrophic gastritis (disorder)	+	?
396337009		Acute and chronic gastritis (disorder)	+	?
1085121000119107		Gastric hemorrhage due to chronic superficial gastritis (di...	+	?

Les synonymes / Terme

Anglais	Français	Néerlandais
Chronic antral gastritis (disorder)		
Chronic antral gastritis		

Liens | Parents : 2 Enfants : 1

+	?	g	->	Relation	Classe	Extr	Nom	Code
				is a	snomed		Chronic gastritis (disorder)	8493009
				is a	snomed	->	Pyloritis (finding)	301456001
				associ...	snomed	->	Chronic inflammation (morphologic abnormality)	84499006
				clinical...	snomed	->	Chronic (qualifier value)	90734009
				finding...	snomed	->	Pyloric antrum structure (body structure)	66051006
				Course	snomed	->	Chronic (qualifier value)	90734009
				is a	snomed	<-	Chronic antral gastritis with hemorrhage (disorder)	698352000

Liens avec les termes

	Libellé	Type	Source	
2268	gastrite antrale	PROB	DOCU	termini_non_liste_19...

Lexical search

Semantic search

SCT Belgian extension

Transmed

Encodage

Term
Code

Pas pertinent Niveau de précision PostCo

Mapping des termes Mapping des codes Recherche de code

Recherche de code

Snomed CT contient gastritis actif

Page 1 sur 1 Codes 1 - 8 sur 8

Code	Version	Nom	+	?
723096000		Gastritis caused by bacterium (disorder)		
723097009		Gastritis caused by fungus (disorder)		
708165001		Gastritis caused by Helicobacter heilmannii (disorder)		
708164002		Gastritis caused by Helicobacter pylori (disorder)		
708964003		Gastritis cystica profunda (disorder)		
4556007		Gastritis (disorder)		
52305004		Gastritis medicamentosa (disorder)		
276527006		Gastritis of newborn (disorder)		

Les synonymes / Terme

Anglais	Français	Néerlandais
Gastritis (disorder)		
Gastritis	Gastritis	gastritis
Gastric catarrh	gastrite	
Gastritis, NOS		

Liens | Parents : 5 Enfants : 41

+	?	g	->	Relation	Classe	Extra	Nom	Code
					cisp2e	- INT	Trouble de la fonction gastrique	D87
				is a	snomed	->	Disorder of stomach (disorder)	29384001
				is a	snomed	->	Inflammatory disorder (disorder)	128139000
				is a	snomed	->	Inflammatory disorder of digestive tract (disorder)	128999004
				is a	snomed	->	Lesion of stomach (finding)	300296006
				is a	snomed	->	Inflammation of specific body organs (disorder)	363169009
				is a	snomed	->	Inflammation (morphologic abnormality)	23583003

Code Nom

Type	Source	
PROB	DOCU	termini_non_liste_19...
2298	gastropathie exsudative	PROB DOCU termini_non_liste_19...

Concepts translated in belgian extension

SCT updates

Transmed

Encodage

Term
Code

Pas pertinent Niveau de précision PostCo

Mapping des termes Mapping des codes Recherche de code

Recherche de code

Snomed CT contient gastritis actif

Page 1 sur 1 Codes 1 - 14 sur 14

Code	Version	Nom	+	?
155717007		Gastritis and duodenitis NOS (disorder)		
196745004		Gastritis and duodenitis NOS (disorder)		
723096000		Gastritis caused by bacterium (disorder)		
723097009		Gastritis caused by fungus (disorder)		
708165001		Gastritis caused by Helicobacter heilmannii (disorder)		
708164002		Gastritis caused by Helicobacter pylori (disorder)		
708964003		Gastritis cystica profunda (disorder)		
235653009		Gastritis (disorder)		
4556007		Gastritis (disorder)		
52305004		Gastritis medicamentosa (disorder)		
276527006		Gastritis of newborn (disorder)		
155711008		Gastritis &/or duodenitis (disorder)		

Les synonymes / Terme

Anglais	Français	Néerlandais
Gastritis (disorder)		
Gastritis	Gastritis	gastritis
Gastric catarrh	gastrite	
Gastritis, NOS		

Parents : 5 Enfants : 41

Classe	Extra	Nom	Code
gastrite	- INT	Trouble de la fonction gastrique	D87
gastrite	->	Disorder of stomach (disorder)	29384001
gastrite	->	Inflammatory disorder (disorder)	128139000
gastrite	->	Inflammatory disorder of digestive tract (disorder)	128999004
gastrite	->	Lesion of stomach (finding)	300296006
gastrite	->	Inflammation of specific body organs (disorder)	363169009
gastrite	->	Inflammation (morphologic abnormality)	23583003

Liens avec les termes

Code	Libellé	Type	Source	termini_non_liste_19...
2282	gastrite fundique	PROB	DOCU	termini_non_liste_19...
2298	gastropathie exsudative	PROB	DOCU	termini_non_liste_19...
2274	gastrite auto-immune	PROB	DOCU	termini_25_8_2016
2278	gastrite d'hypertension portale	PROB	DOCU	termini_non_liste_19...

Old concepts

Semantic browsing

Term
Code

Pas pertinent Niveau de precision

PostCo

Mapping des termes Mapping des codes Rec

Recherche de code

Snomed CT

Page 1 sur 1

Code	Version	Nom
8493009		Chronic gastritis (dis
698352000		Chronic antral gastrit
89790007		Chronic antral gastrit
235661004		Chronic cystic gastrit
63137003		Chronic erosive gastr
235660003		Chronic follicular gas
235662006		Chronic granulomato
196735001		Chronic superficial ga

Liens

89790007 Chronic antral gastritis (disorder) | Parents : 2 Enfants : 1

+	?	g	->	Relation	Classe	Extra	Nom	Code
				is a	snomed	->	Chronic gastritis (disorder)	8493009
				is a	snomed	->	Pyloritis (finding)	301456001
				associated mor...	snomed	->	Chronic inflammation (morphologic abnormality)	84499006

Liens

698352000 Chronic antral gastritis with hemorrhage (disorder) | Parents : 2 Enfants : 0

+	?	g	->	Relation	Classe	Extra	Nom	Code
				is a	snomed	->	Gastric hemorrhage (disorder)	61401005
				is a	snomed	->	Chronic antral gastritis (disorder)	89790007
				associated mor...	snomed	->	Chronic hemorrhagic inflammation (morphologic abnorm...	49100009
				clinical course	snomed	->	Chronic (qualifier value)	90734009
				finding site	snomed	->	Pyloric antrum structure (body structure)	66051006

Semantic graphical browsing

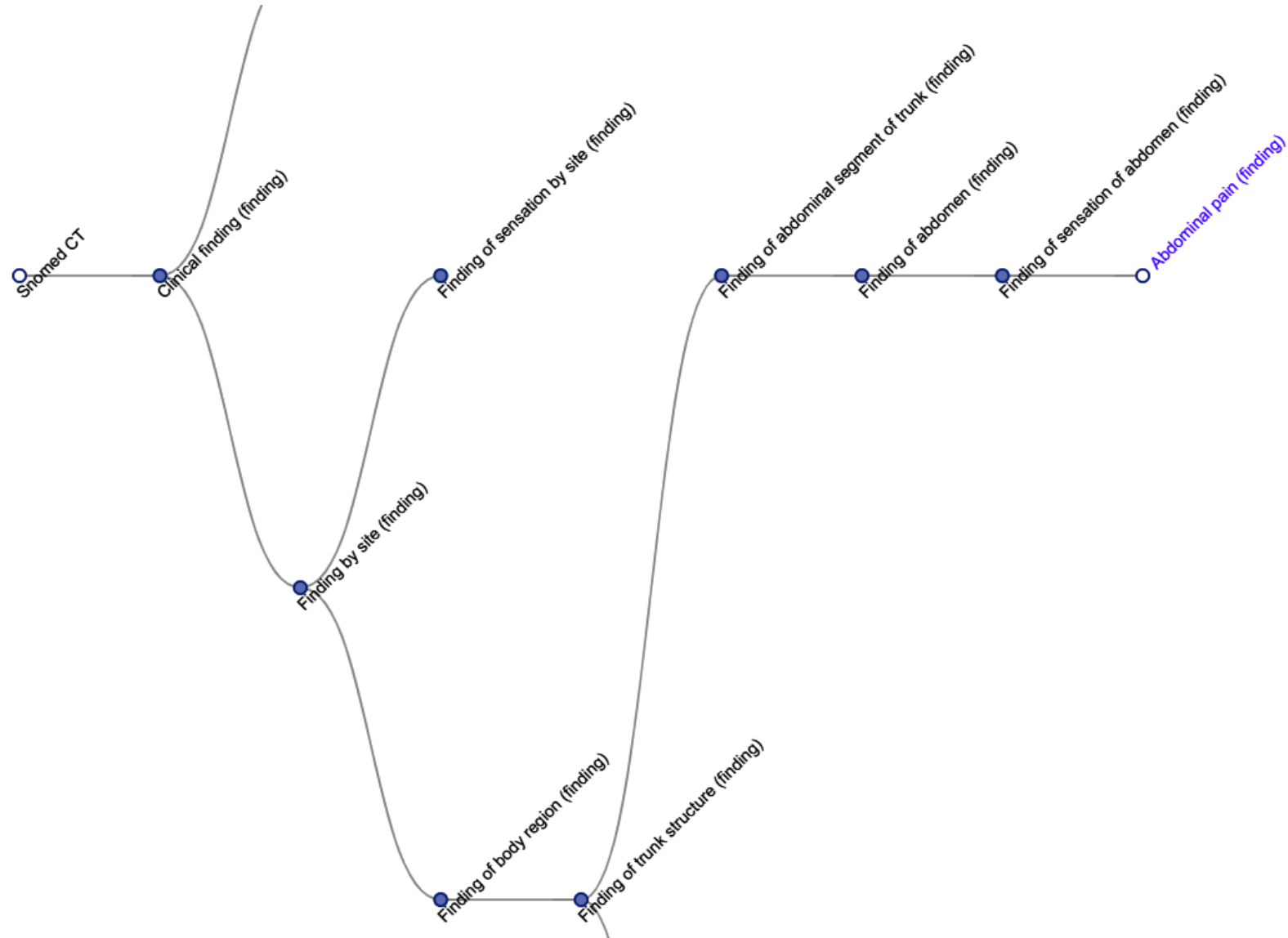

Choosing the right concept

▶ Pin-it

▶ Precision level

- ▶ Exact match
- ▶ Narrow to broad
- ▶ Broad to narrow
- ▶ No match (no concept pinned)

Diarrhée aiguë sanglante	Narrow to broad (NtB)	Diarrhée aiguë
Diarrhée	Broad to narrow (BtN)	Diarrhée aiguë
Diarrhée aiguë	Exact Match (EM)	Diarrhée aiguë

3 - Coders benchmark

Transmed



Encodage

Pas pertinent Niveau de precision PostCo

Mapping des termes Mapping des codes Recherche de code

Codé Validé Pas pertinent PostCo IBUI-TEST Neederlands Catégorie Type ivanoverschelde evancampen Export Tous

Page 2 sur 5

id		->	<->		v	v	v	v	->	x	<->		v	v	v	v	->	x
10035182	gastritis	4556007	Gastritis (disorder)	EM	✓	✗	✗	✗	4556007	Gastritis (disorder)	EM	✓	✗	✗	✗	4556007	Gastritis (disorder)	EM
10035231	virale gastro-enteritis	111843007	Viral gastroenteritis (disorder)	EM	✓	✗	✗	✗	111843007	Viral gastroenteritis (disorder)	EM	✓	✗	✗	✗	111843007	Viral gastroenteritis (disorder)	EM
10036310	geïnfecteerde urine	102866000	Abnormal urine (finding)	NA	✓	✗	✗	✗	68566005	Urinary tract infectious disease (disorder)	NA	✓	✗	✗	✗	68566005	Urinary tract infectious disease (disorder)	NA
10038382	glucose intolerantie	237597000	Disorder of glucose regulation (disorder)	BR	✓	✗	✗	✗	9414007	gestoorde glucosetolerantie	EM	✓	✗	✗	✗	9414007	gestoorde glucosetolerantie	EM
10039597	handpijn	53057004	Hand pain (finding)	EM	✓	✗	✗	✗	53057004	Hand pain (finding)	EM	✓	✗	✗	✗	53057004	Hand pain (finding)	EM
10041728	hoesten	49727002	hoesten	EM	✓	✗	✗	✗	49727002	hoesten	EM	✓	✗	✗	✗	49727002	hoesten	EM
10041859	hoofdpijn	25064002	hoofdpijn	EM	✓	✗	✗	✗	25064002	hoofdpijn	EM	✓	✗	✗	✗	25064002	hoofdpijn	EM
10042065	huidmycose	14560005	Dermal mycosis (disorder)	EM	✓	✗	✗	✗	14560005	Dermal mycosis (disorder)	EM	✓	✗	✗	✗	14560005	Dermal mycosis (disorder)	EM
10042098	open wond van huid	262526004	Wound of skin (disorder)	EM	✓	✗	✗	✗	125643001	Open wound (disorder)	NA	✓	✗	✗	✗	125643001	Open wound (disorder)	NA
10043211	hypercholesterolemie	13644009	Hypercholesterolemia (disorder)	EM	✓	✗	✗	✗	13644009	Hypercholesterolemia (disorder)	EM	✓	✗	✗	✗	13644009	Hypercholesterolemia (disorder)	EM
10043331	hyperkaliëmie	14140009	Hyperkalemia (disorder)	EM	✓	✗	✗	✗	14140009	Hyperkalemia (disorder)	EM	✓	✗	✗	✗	14140009	Hyperkalemia (disorder)	EM
10043369	hyperlipidemie	55822004	Hyperlipidemia (disorder)	EM	✓	✗	✗	✗	55822004	Hyperlipidemia (disorder)	EM	✓	✗	✗	✗	55822004	Hyperlipidemia (disorder)	EM
10045653	acute bovenste luchtweginfectie	54398005	Acute upper respiratory infection (disorc)	EM	✓	✗	✗	✗	54398005	Acute upper respiratory infection (disorder)	EM	✓	✗	✗	✗	54398005	Acute upper respiratory infection (disorder)	EM

4 - Export results

Transmed

Encodage Export

Pas pertinent Niveau de precision PostCo

Mapping des termes Mapping des codes Recherche de code

Codé Validé Pas pertinent PostCo IBUI-TEST Neederlands Catégorie Type ivanoverschelde evancampen Export Tous

10011161	benigne paroxysmale vertigo	🔴								111541001	benigne paroxysmale positie vertigo	EM	✓	🔴
10014706	braken	🔴								249497008	Vomiting symptom (finding)	EM	✓	🔴
10015274	bronchitis	🔴								32398004	Bronchitis (disorder)	EM	✓	🔴
10023755	cystitis	🔴								38822007	Cystitis (disorder)	EM	✓	🔴
10024489	ijzerdeficiëntie	🔴								35240004	ijzerdeficiëntie	EM	✓	🔴
10027911	dysfagie	🔴								40739000	dysfagie	EM	✓	🔴
10027977	dysmenorroe	🔴								266599000	Dysmenorrhea (disorder)	EM	✓	🔴
10028068	dyspnoe	🔴								267036007	dyspnoe	EM	✓	🔴
10030319	epicondylitis lateralis	🔴								202855006	Lateral epicondylitis (disorder)	EM	✓	🔴
10031563	acute COPD exacerbatie	🔴								13645005	Chronic obstructive lung disease (disord	NA	✓	🔴
10035182	gastritis	🔴	4556007	Gastritis (disorder)	EM	✓	🔴	🗑		4556007	Gastritis (disorder)	EM	✓	🔴
10035231	virale gastro-enteritis	🔴	111843007	Viral gastroenteritis (disorder)	EM	✓	🔴	🗑		111843007	Viral gastroenteritis (disorder)	EM	✓	🔴
10036310	geïnfecteerde urine	🔴	102866000	Abnormal urine (finding)	NA	✓	🔴	🗑		68566005	Urinary tract infectious disease (disorder)	NA	✓	🔴
10039597	handpijn	🔴	53057004	Hand pain (finding)	EM	✓	🔴	🗑		53057004	Hand pain (finding)	EM	✓	🔴
10041728	hoesten	🔴	49727002	hoesten	EM	✓	🔴	🗑		49727002	hoesten	EM	✓	🔴
10041859	hoofdpijn	🔴	25064002	hoofdpijn	EM	✓	🔴	🗑		25064002	hoofdpijn	EM	✓	🔴
10042065	huidmycose	🔴	14560005	Dermal mycosis (disorder)	EM	✓	🔴	🗑		14560005	Dermal mycosis (disorder)	EM	✓	🔴
10043211	hypercholesterolemie	🔴	13644009	Hypercholesterolemia (disorder)	EM	✓	🔴	🗑		13644009	Hypercholesterolemia (disorder)	EM	✓	🔴
10043331	hyperkaliëmie	🔴	14140009	Hyperkalemia (disorder)	EM	✓	🔴	🗑		14140009	Hyperkalemia (disorder)	EM	✓	🔴

